

Flooring Complements

Skirting



06/2019 BE SL EN 5

**Schotten
& Hansen**

Nature Refined.

Skirting

Dimensions

	A total height incl. 1,5 mm glazing tape	B Thickness	C Length	D Construction	E Kind of wood
F4a	65	20	2000-4000	Solid	Oak
F4b	45	20	2000-4000	Solid	Oak
F18	94	20	2000-4000	Solid	Oak
S55	55	17	2000-4000	Solid	Oak
S55 Laquered in White (RAL 9010)	55	17	2000-4000	Solid	Yellow Poplar

All dimensions in mm

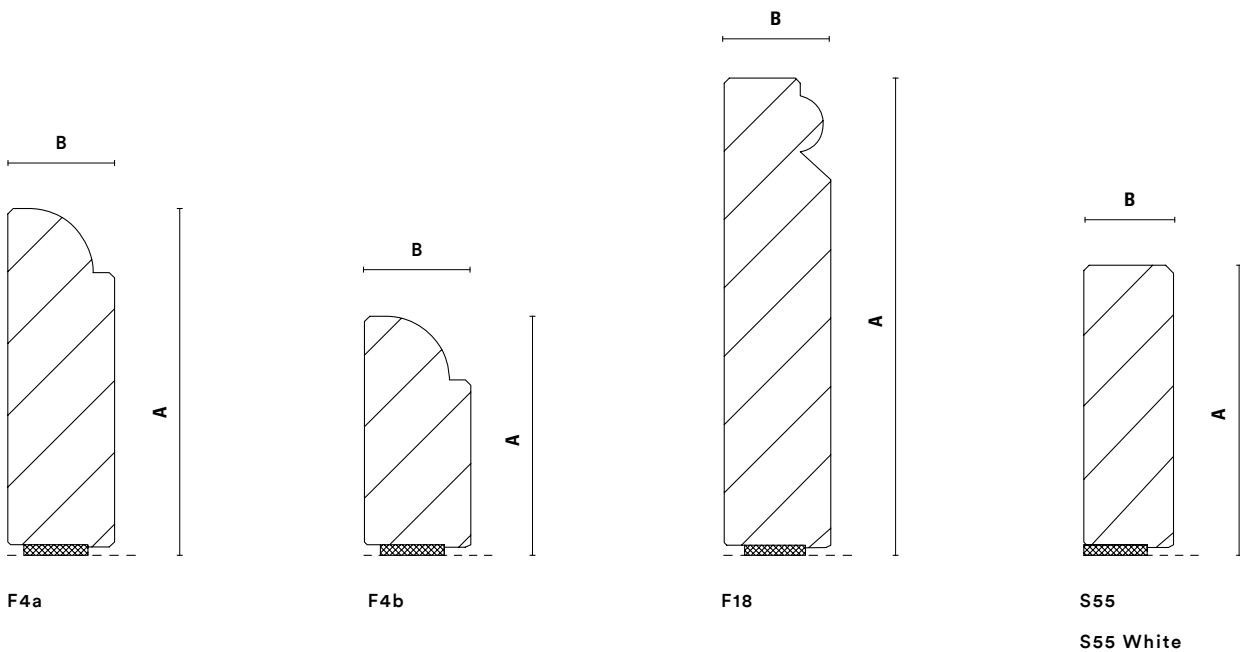

Skirting

Specifications

Profile F4a

Height A**	65 mm
Thickness B**	20 mm
Length C	2000-4000 mm
Construction***	Solid Oak
Colours*	20 Colours (EI01-EI19) special colours on request
Selection	01 Fine
Treatment	01 Brushed
Sound protection according to DIN 4109	Separation from the flooring by a waterresistant, elastic glazing tape.
Installation*	Screwed with ball head screws from brass or stainless steel*. Glued. Installation according to DIN 18356.
Requirements	Planarity of the wall according to DIN 18202 chart 3, line 7, increased requirements. Plastered wall. Completely mounted flooring. Guidelines to sound protection according to DIN 4109.

All dimensions in mm | *to choose | **different measurements on request | ***other wood species and variations on request

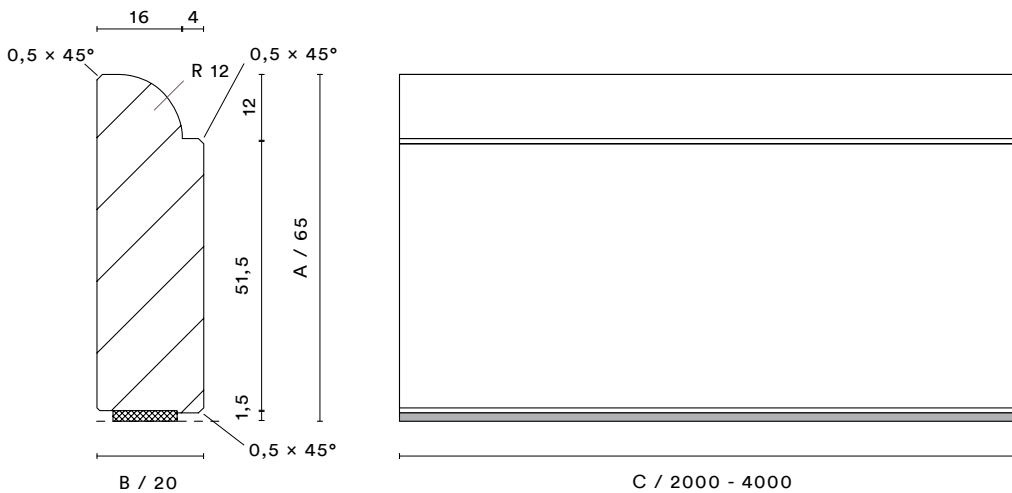

Skirting

Specifications

Profile F4b

Height A**	45 mm
Thickness B**	20 mm
Length C	2000-4000 mm
Construction***	Solid Oak
Colours*	20 Colours (EI01-EI19) special colours on request
Selection	01 Fine
Treatment	01 Brushed
Sound protection according to DIN 4109	Separation from the flooring by a waterresistant, elastic glazing tape.
Installation*	Screwed with ball head screws from brass or stainless steel*. Glued. Installation according to DIN 18356.
Requirements	Planarity of the wall according to DIN 18202 chart 3, line 7, increased requirements. Plastered wall. Completely mounted flooring. Guidelines to sound protection according to DIN 4109.

All dimensions in mm | *to choose | **different measurements on request | ***other wood species and variations on request

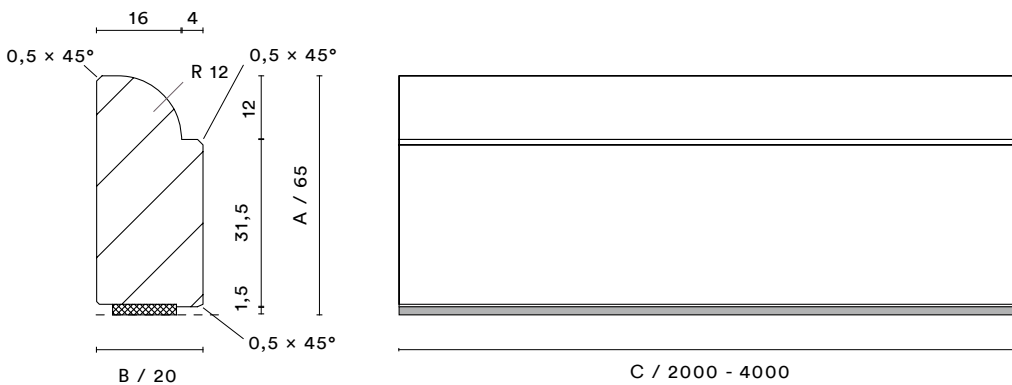

**Schotten
&Hansen**

Skirting

Specifications

Profile F18

Height A**	94 mm
Thickness B**	20 mm
Length C	2000-4000 mm
Construction***	Solid Oak
Colours*	20 Colours (EI01-EI19) special colours on request
Selection	01 Fine
Treatment	01 Brushed
Sound protection according to DIN 4109	Separation from the flooring by a waterresistant, elastic glazing tape.
Installation*	Screwed with ball head screws from brass or stainless steel*. Glued. Installation according to DIN 18356.
Requirements	Planarity of the wall according to DIN 18202 chart 3, line 7, increased requirements. Plastered wall. Completely mounted flooring. Guidelines to sound protection according to DIN 4109.

All dimensions in mm | *to choose | **different measurements on request | ***other wood species and variations on request

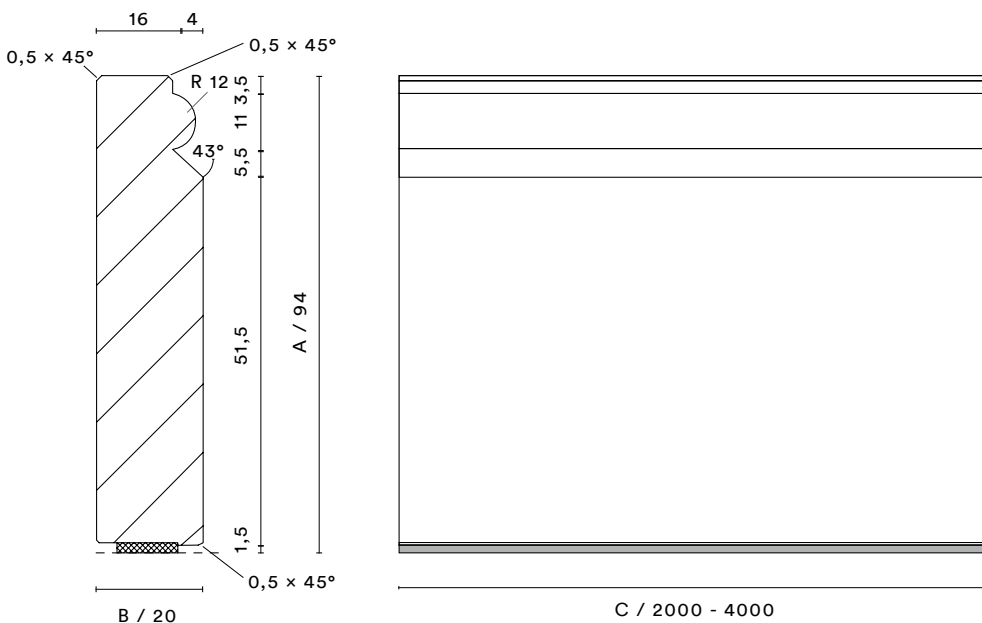

**Schotten
&Hansen**

Skirting

Specifications

Profile S55

Height A**	55 mm
Thickness B**	17 mm
Length C	2000-4000 mm
Construction***	Solid Oak, White: Yellow Poplar
Colours*	20 Colours (EI01-EI19) special colours on request White, RAL 9010
Selection	01 Fine
Treatment	01 Brushed
Sound protection according to DIN 4109	Separation from the flooring by a waterresistant, elastic glazing tape.
Installation*	Screwed with ball head screws from brass or stainless steel*. Glued. Installation according to DIN 18356.
Requirements	Planarity of the wall according to DIN 18202 chart 3, line 7, increased requirements. Plastered wall. Completely mounted flooring. Guidelines to sound protection according to DIN 4109.

All dimensions in mm | *to choose | **different measurements on request | ***other wood species and variations on request

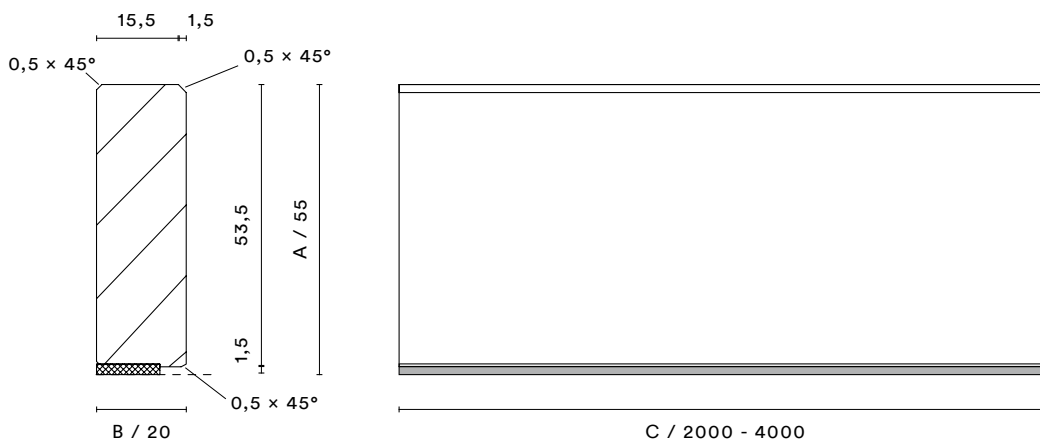

**Schotten
&Hansen**